

Standart Bezeichnung: AS 53 B2 Standard Modell: AS 53 B2Ä Jahr: 2002

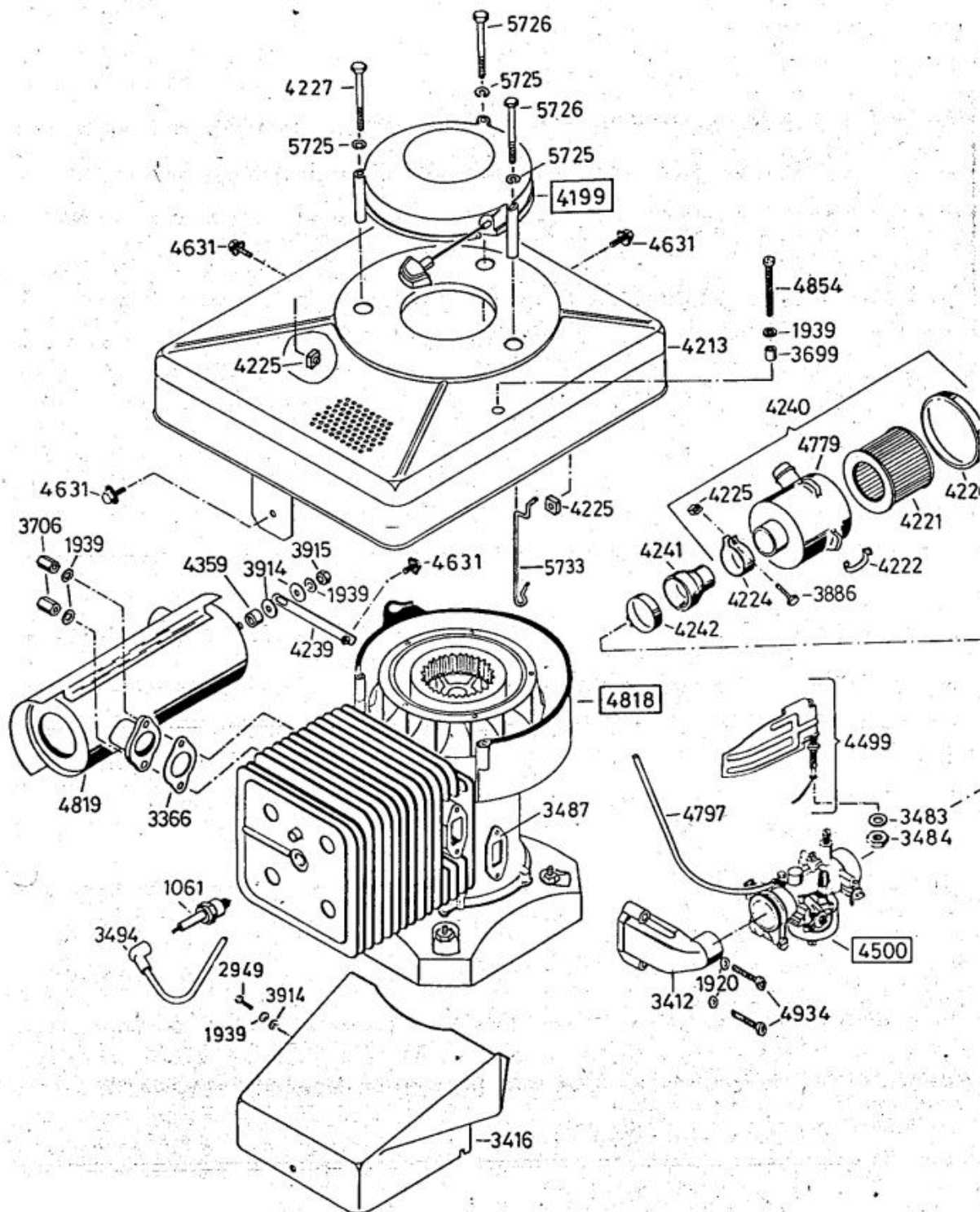

4818 Antriebsblock
driving unit
moteur complet

Standart Bezeichnung: AS 53 B2 Standard Modell: AS 53 B2Â Jahr: 2002

DOB

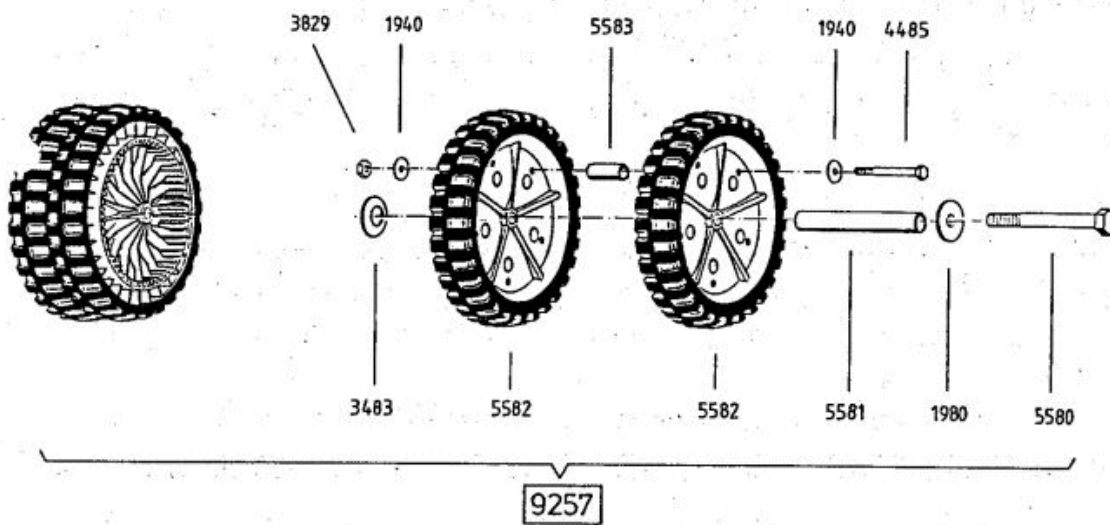

Standart Bezeichnung: AS 53 B2 Standard Modell: AS 53 B2Â Jahr: 2002

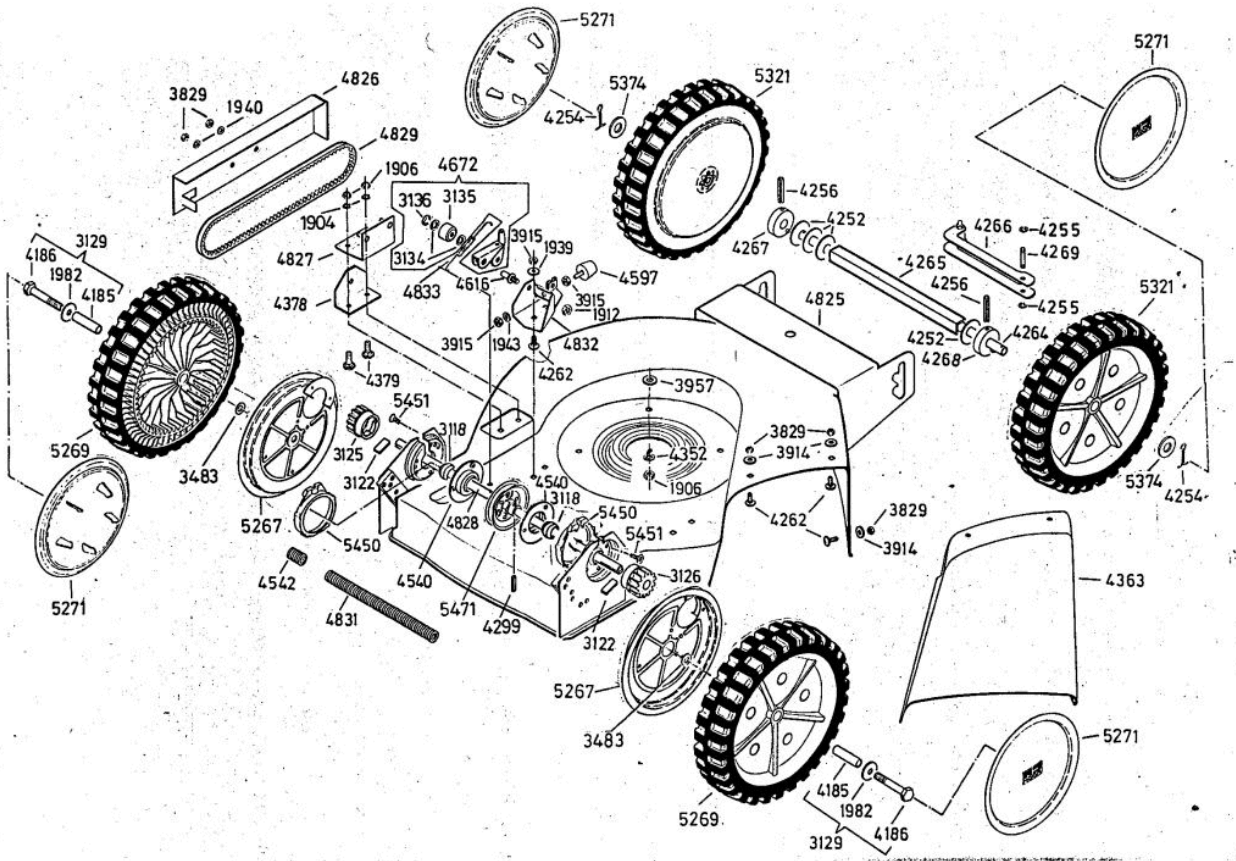

Standart Bezeichnung: AS 53 B2 Standard Modell: AS 53 B2Ä Jahr: 2002

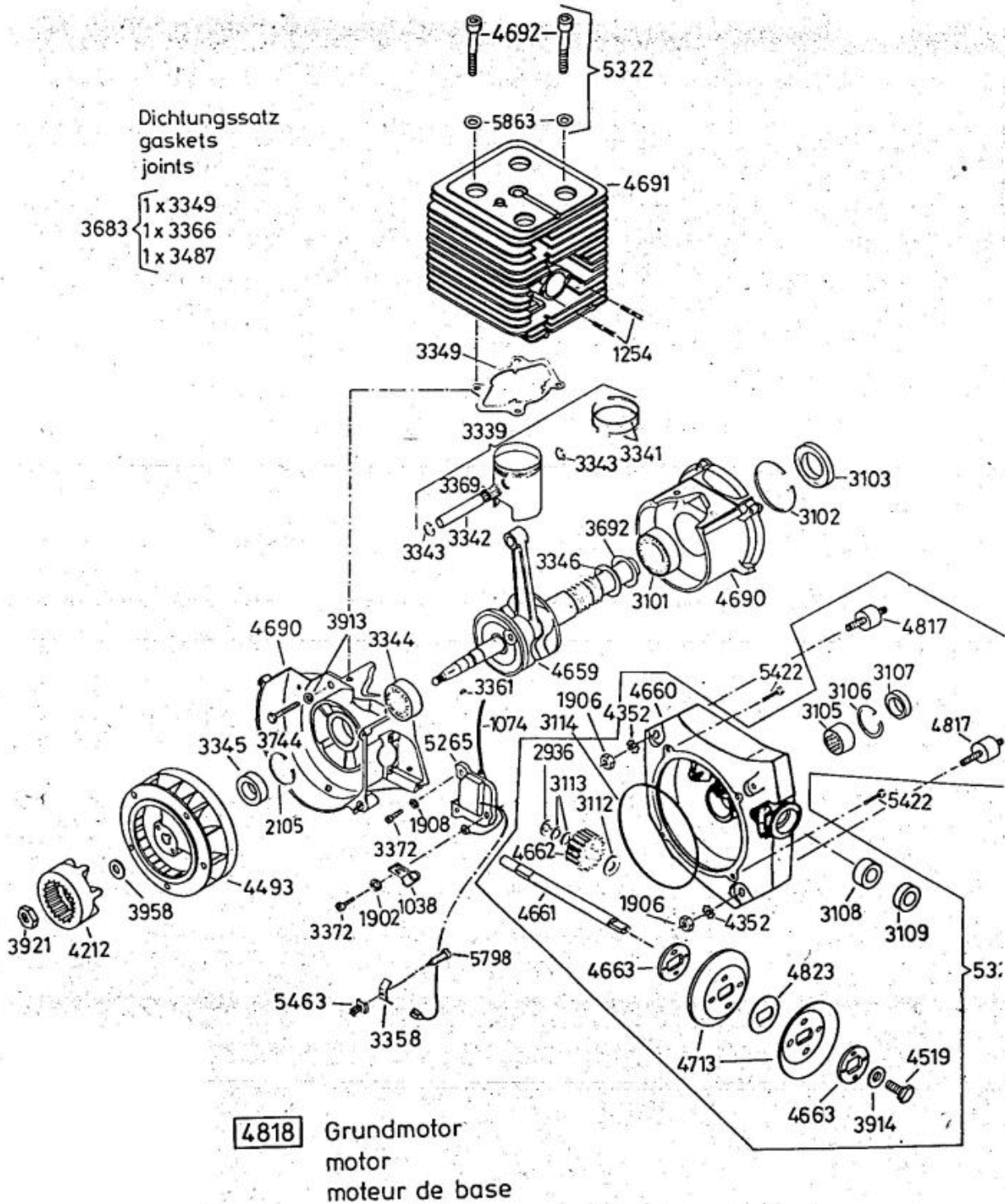

Standart Bezeichnung: AS 53 B2 Standard Modell: AS 53 B2Ä Jahr: 2002

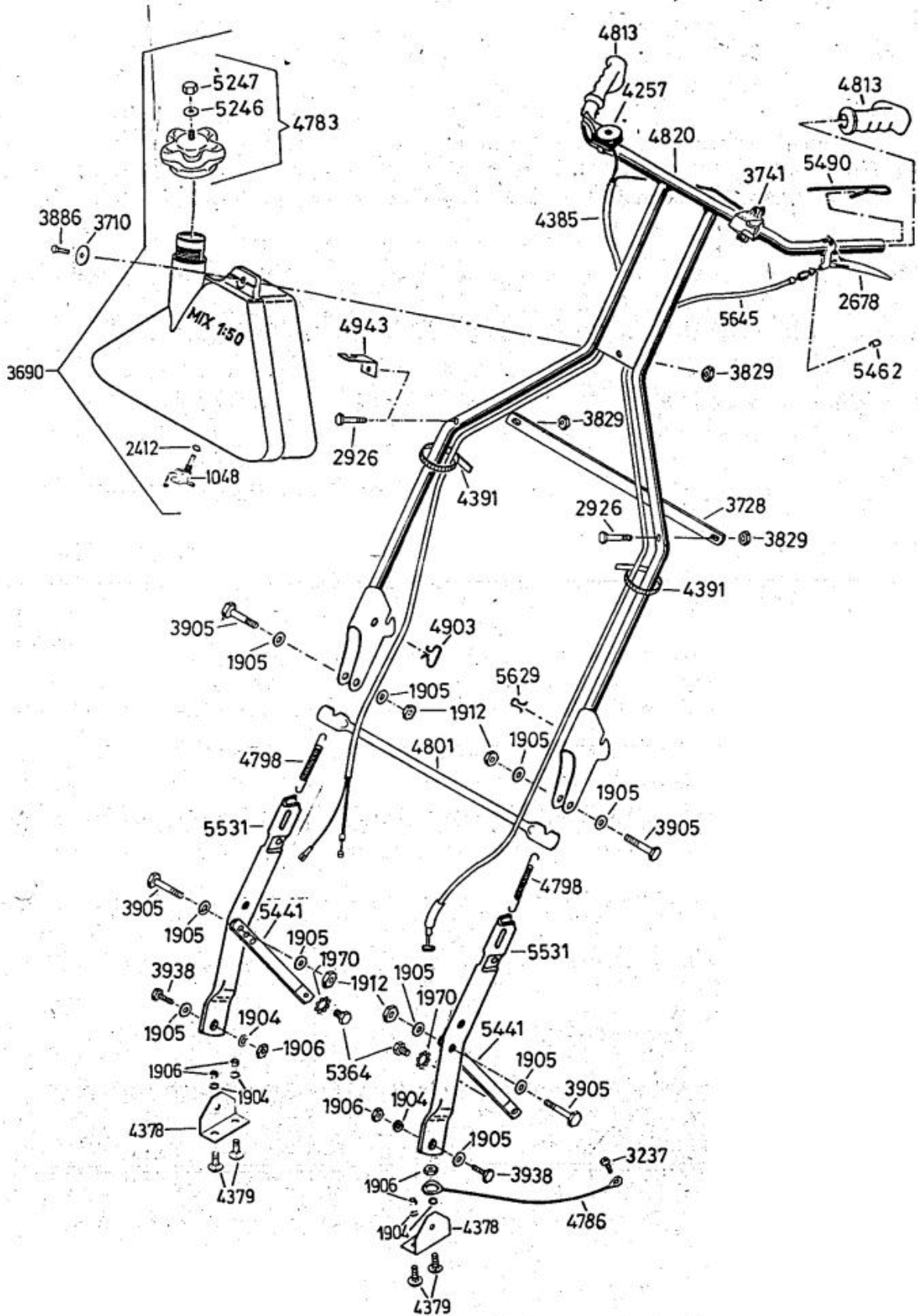

Standart Bezeichnung: AS 53 B2 Standard Modell: AS 53 B2Ä Jahr: 2002

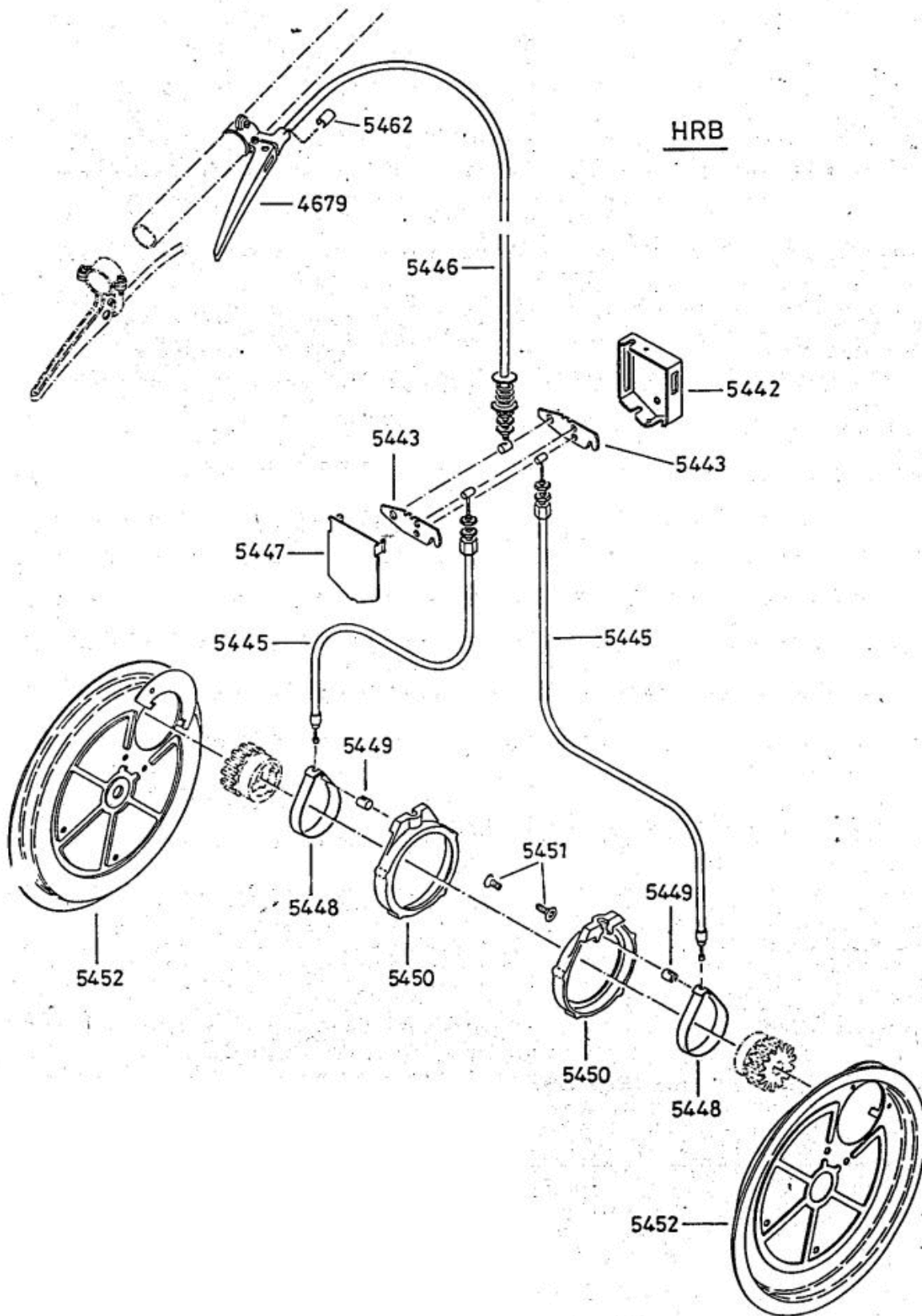

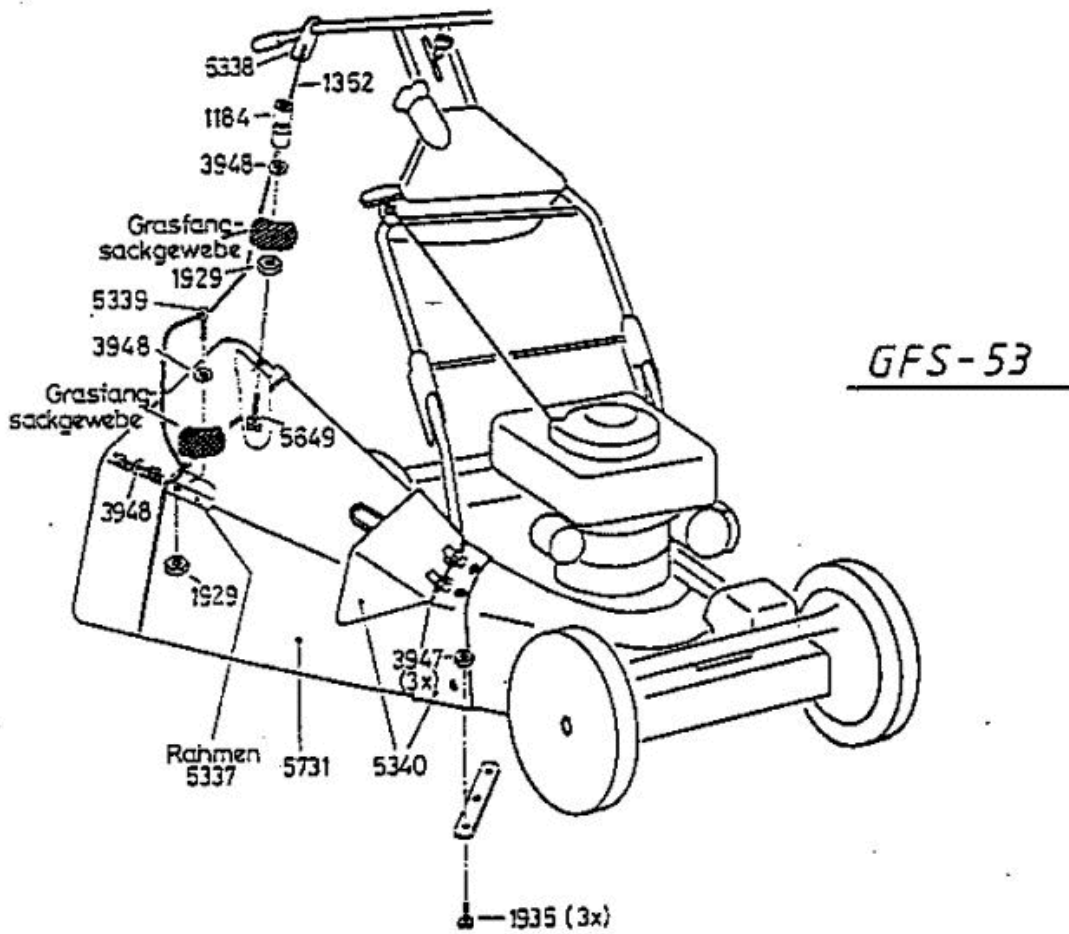

Standart Bezeichnung: AS 53 B2 Standard Modell: AS 53 B2Â Jahr: 2002

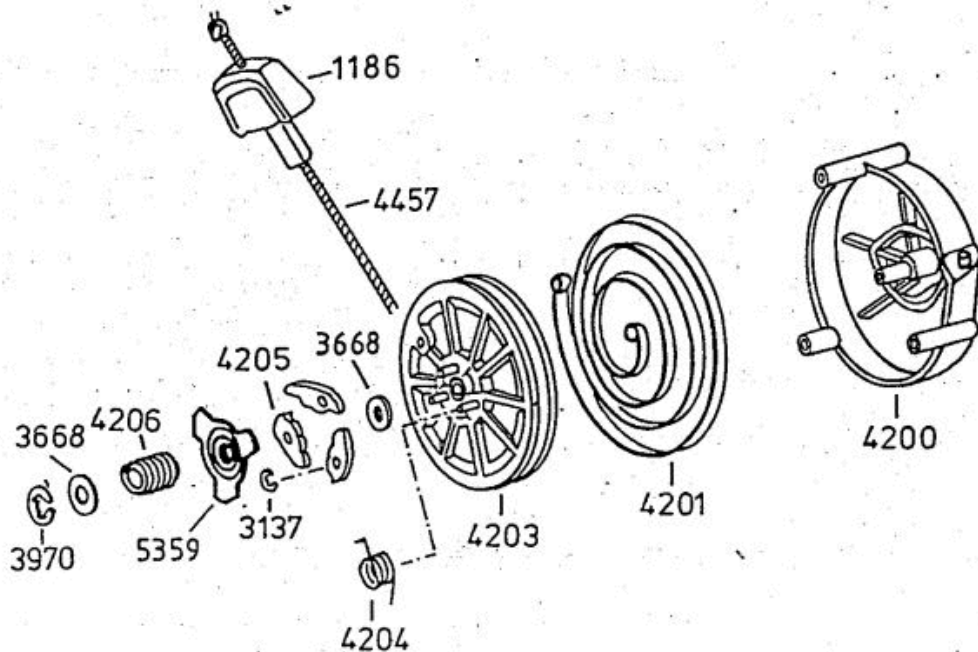

4199

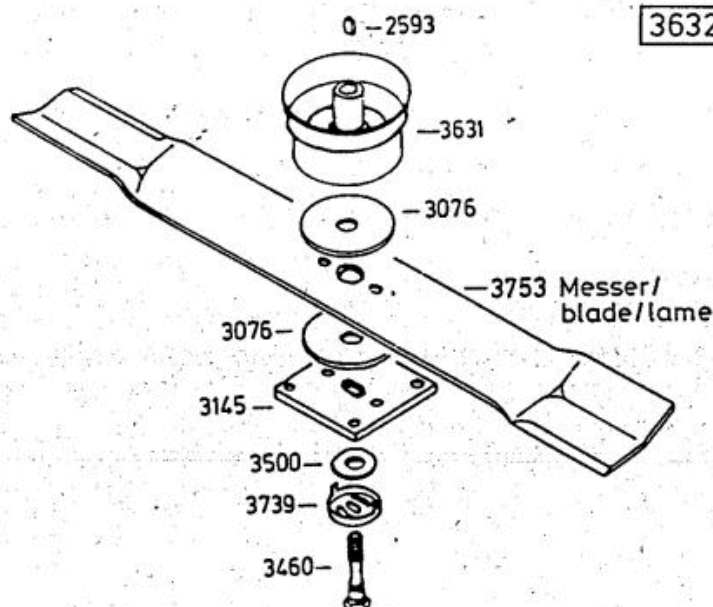

3632 -Rutschkupplung
ohne Messer
-friction clutch
without blade
-l'embrayage à
friction sans lame

Standart Bezeichnung: AS 53 B2 Standard Modell: AS 53 B2Ä Jahr: 2002

